



eArc™ PV System

Installation Manual

Contents

Purpose of this guide

Features & Benefits

Notices

General safety

Handling safety

Installation safety

Fire safety

Production Identification

Mechanical Installation

Grounding

Electrical installation

Maintenance and care

Disclaimer of liability

Products Data

Purpose of this guide

- This guide contains information regarding the installation and safe handling of Sunman (Zhenjiang) Company Limited eArc PV system. Sunman (Zhenjiang) Company Limited referred to as “SUNMAN”.
- Installers must read and understand this guide prior to installation. For any questions, please contact SUNMAN’s Customer Service Department “or our local representatives” for more detailed information. Installers should follow all safety precautions described in this guide as well as local codes when installing a eArc.
- Before installing a solar photovoltaic system, installers should familiarize themselves with its mechanical and electrical requirements. Keep this guide in a safe place for future reference (care and maintenance) and in case of sale or disposal of eArc.
- SUNMAN’s eArc are tested and certified for installations worldwide. Different regions may have different regulations for solar PV installations.

Features & Benefits

- Flexible layouts
- eArc™ PV system can be installed at any shape roofs, which has integrated appearance with buildings. Providing aesthetic seamless look.
- Maximization installation coverage of panels over any kind of roof.
- Quick installation
- Ultra-thin and light design to save installation labour

Notices

This manual contains important installation instructions for the core hardware components required for eArc™ PV System PV arrays.

Copyright and Trademark Information

Copyright © 2019 by Sunman (Zhenjiang) Company Limited. All rights reserved.

eArc and the SUNMAN logo are trademarks of Sunman (Zhenjiang) Company Limited.

Warranty Warnings

“WARRANTY VOID IF NON-SUNMAN-CERTIFIED HARDWARE IS ATTACHED TO eArc™ PV System.”

For Further Information

For additional technical support documentation, please visit the Support page of the SUNMAN web site at www.sunman-energy.com

General safety

- eArc that fall under this application class may be used in system operation at more than 50V DC or 240W, where general contact access is anticipated. eArc are qualified for safety under IEC 61730-2 and within this application class are considered to meet the requirements for Safety Class II.
- eArc are qualified for Application Class A(IEC 61730-1).
- Installing solar photovoltaic systems requires specialized skills and knowledge. Installation should only be performed by qualified personnel.
- Installers should assume all risks of injury that might occur during installation, including, but not limited to, the risk of electric shock.
- One single eArc may generate more than 30V DC when exposed to direct sunlight. Contact with a DC voltage of 30V or more is potentially hazardous.
- Do not disconnect during load connection.
- Photovoltaic solar eArc convert light energy to direct current electrical energy. They are designed for outdoor use. eArc can be ground mounted, mounted on rooftops, vehicles or boats. The proper design of support structures lies within the responsibility of the system designers and installers.
- Do not use mirrors or other magnifiers to concentrate sunlight onto eArc.
- When installing the system, abide to all local, regional and national statutory regulations. Obtain a building permit if necessary.
- eArc electrical characteristics are within $\pm 10\%$ of the indicated values of I_{sc} , V_{oc} and P_{max} under standard test conditions (Irradiance of $1000W/m^2$, AM 1.5 spectrum, a cell temperature of $25^{\circ}C$).
- Only use equipment, connectors, wiring and support frames suitable for solar electrical systems.
- “Always use fall protection equipment when working from heights of 6 feet (183cm) or above”. Follow Occupational Safety and Health Act (OSHA) or local governing safety regulations regarding fall protection. (UL only)

Handling safety

- Do not lift eArc by grasping eArc' junction box or electrical leads.
- Do not stand, step or walk on any side of eArc.
- Do not drop eArc or allow objects to fall on eArc.
- Do not place any heavy objects on eArc.
- Be cautious when placing eArc down onto a surface, particularly when placing it in a corner.
- Inappropriate transport and installation may damage eArc panel and void the warranty.
- Do not attempt to disassemble eArc, and do not remove any attached nameplates or components from eArc.
- Do not apply paint or adhesive to eArc' top surface.
- To avoid damage to the front cover and backsheet: do not scratch, dent or hit the front cover and backsheet.
- Do not drill holes in the ribs. This may compromise the frame strength, cause corrosion of the ribs and void the warranty.
- Do not scratch the anodized coating of the ribs (except for grounding connection). It may cause corrosion of the ribs or compromise the ribs strength.
- A panel with broken front plate or torn back sheet cannot be repaired and must not be used since contact with any panel surface or the ribs can cause an electric shock.
- Work only under dry conditions, and use only dry tools. Do not handle panels under wet conditions unless wearing appropriate protective equipment.
- When storing uninstalled panels outdoors for any period of time, always cover the panels and ensure that the front cover faces down “on a soft flat surface” to prevent water from collecting inside the panel and causing damage to exposed connectors.

Installation safety

- Never open electrical connections or unplug connectors while the circuit is under load.
- Contact with electrically charged parts of the panels, such as terminals, can result in burns, sparks and lethal shock whether or not the panel is connected.
- Do not touch eArc unnecessarily during installation. The front surface and the ribs may be hot; there is a risk of burns and electric shock.
- Do not work in the rain, snow or in windy conditions.
- Avoid exposing cables to direct sunlight in order to prevent insulation degradation.
- Keep children well away from the system while transporting and installing mechanical and electrical components.
- Completely cover eArc with an opaque material during installation to prevent electricity from being generated.
- Do not wear metallic rings, watchbands, earrings, nose rings, lip rings or other metallic objects while installing or troubleshooting photovoltaic systems.
- Use only insulated tools that are approved for working on electrical installation.
- Follow the safety regulations for all other system components, including wires and cables, connectors, charging regulators, inverters, storage batteries, rechargeable batteries, etc.
- Under normal conditions, a photovoltaic eArc is likely to experience conditions that produce more current and/or voltage than reported at standard test conditions. Accordingly, the values of I_{sc} and V_{oc} marked on this eArc should be multiplied by a factor of 1.25 when determining component voltage ratings, conductor current ratings, fuse sizes, and size of controls connected to the PV output.
- Only use same or connectable connectors to connect eArc to form a string, or connect to another device. Removing the connectors will void the warranty.

Fire safety

- Consult your local authority for guidelines and requirements for building or structural fire safety.
- Roof constructions and installations may affect the fire safety of a building; improper installation may create hazards in the event of a fire.
- Use components such as ground fault circuit breakers and fuses as required by local authority.
- Do not use panels near equipment or in places where flammable gases may be generated.
- eArc have been rated Fire Class C, and are suitable for mounting on to a Class A roof.

Production Identification

Each eArc has two labels providing the following information:

- Nameplate: describes the product type; rated power, rated current, rated voltage, open circuit voltage, short circuit current, all as measured under standard test conditions; weight, dimensions etc.; the maximum system voltage is 1000 volts.
- Barcode: each individual eArc has a unique serial number. The serial number has 18 digits. The 1th to 4th digits are the module type for internal use, and the 5th and the 6th digits are the year code, and the 7th and 8th digits are the month and the 9th and the 10th digits are the week code, and the 11th and the 15th digits are order number, and the 16th and the 18th digits are the sequence codes. For example, XXXX160417XXXXXXXX means the module was made in the 17th week of 2016. Each module has only one bar code. It is permanently attached to the interior of eArc and is visible from the top front of eArc. This bar code is inserted prior to lamination.



Mechanical Installation

Selecting the location

- Select a suitable location for installing eArc.
- eArc should face south in northern latitudes and north in southern latitudes to maximise generation.
- For detailed information on the best installation angle, refer to standard solar photovoltaic installation guides or consult a reputable solar installer or systems integrator.
- eArc should not be shaded at any time. If an eArc is shaded or even partially shaded, it will fail to perform at ideal conditions and result in lower power output.
- Do not use eArc near equipment or in locations where flammable gases may be generated or collected.

General installation

- eArc mounting structure must be made of durable, corrosion-resistant and UV-resistant material.
- Always observe the instructions and safety precautions included with eArc support frames.
- Do not drill additional mounting holes in the PV panel's ribs as this will void the warranty.
- Before installing eArc on a roof, always ensure the roof construction is suitable. In addition, any roof penetration required to mount eArc must be properly sealed to prevent leaks.
- Dust building up on the surface of eArc can impair with eArc performance. SUNMAN recommends installing eArc with a tilt angle of at least 10 degrees, making it easier for dust to be washed off by rain.
- Always keep the back sheet of the panel free from foreign objects, "plants and vegetation", or structural elements, which could come into contact with the panel, especially when the panel is under mechanical load.
- Ensure panels are not subject to wind or snow loads exceeding the maximum permissible loads, and are not subject to excessive forces due to the thermal expansion of the support structures: Refer to the following installation methods for more detailed information.

eArc product design loads

- All eArc™ product have been evaluated for test loads of 2400 Pa with the following solutions.

Mechanical Installation

Quick-bonding Installation

►For SMD and SMF Series

SMDxxxM-6X12DW; SMDxxxM-6X10DW; SMDxxxM-4X12DW; SMDxxxM-4X09DW;
SMDxxxM-6X12UW; SMDxxxM-6X10UW; SMDxxxM-4X12UW; SMDxxxM-4X09UW;
SMDxxxF-6X24DW; SMDxxxF-6X20DW; SMDxxxF-4X24DW; SMDxxxF-4X18DW;
SMDxxxF-6X24UW; SMDxxxF-6X20UW; SMDxxxF-4X24UW; SMDxxxF-4X18UW;
SMDxxxF-6X24DB; SMDxxxF-6X20DB; SMDxxxF-4X24DB; SMDxxxF-4X18DB;

SMDxxxF-6X24UB; SMDxxxF-6X20UB; SMDxxxF-4X24UB; SMDxxxF-4X18UB;
 SMFxxxM-6X12DW; SMFxxxM-6X10DW; SMFxxxM-4X12DW; SMFxxxM-4X09DW;
 SMFxxxM-6X12UW; SMFxxxM-6X10UW; SMFxxxM-4X12UW; SMFxxxM-4X09UW; SMFxxxM-5X12UW;
 SMFxxxF-6X24DW; SMFxxxF-6X20DW; SMFxxxF-4X24DW; SMFxxxF-4X18DW;
 SMFxxxF-6X24UW; SMFxxxF-6X20UW; SMFxxxF-4X24UW; SMFxxxF-4X18UW;
 SMFxxxF-6X24DB; SMFxxxF-6X20DB; SMFxxxF-4X24DB; SMFxxxF-4X18DB;
 SMFxxxF-6X24UB; SMFxxxF-6X20UB; SMFxxxF-4X24UB; SMFxxxF-4X18UB;

► **List Of Tools Required For Installation**

- Sunman SMD / SMF panel
- Automatic Silicone caulking gun + nozzle
- EITHER Tonsan 1527 and Isopropyl alcohol OR Sika Sikasil SG-20 and Sika Aktivator-205
- Rags / flat cloth mop
- String line
- Portable water pump / pest control pump
- Optional: Sika Double sided tape

► **Overview**

The Sunman SMD Series use quick and easy installation method which is called “Quick-bonding”. Quick bonding allows you to install a Sunman SMD module directly to an approved metal surface using an approved structural grade silicone. Quick bonding can be direct to the roof or on Aluminium 6065-T5 raining, such as the product from Unistrut. Please ensure the surface is clean, free of dust and debris, before application as this may inhibit adhesion.

Please note: Please contact Sunman to complete Installation training before attempting your first installation.

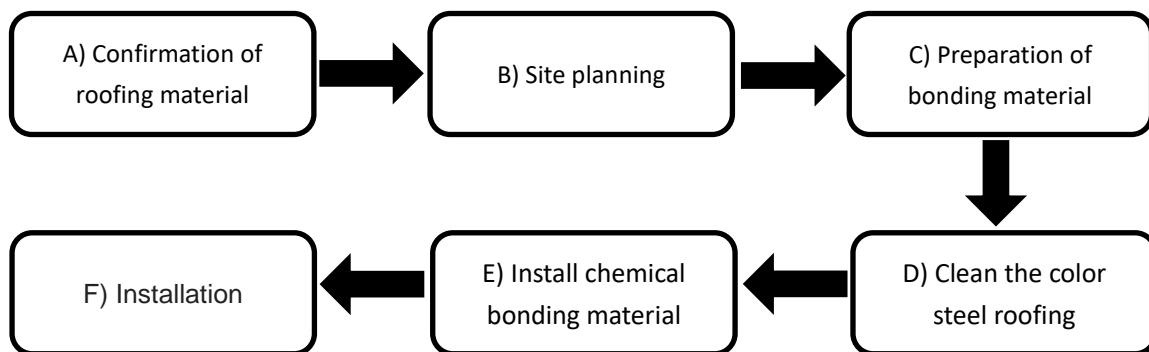

a. Confirmation of roofing material

- Please clearly identify the roof material before installation as the type of the roof material directly affects the strength of the adhesion.

- Sika Sikasil SG-20 is suitable to be used on: BlueScope Colorbond steel (excluding matte finishes), Zinalume and Aluminium 6065-T5
- Tonsan 1527 is suitable to be used on: BlueScope Colorbond steel (Surfmist, Shale Grey, Windspray, Woodland Grey, Monument, Pale Eucalypt, Ironstone, Dune. Excluding matte finishes), Zinalume and Aluminium 6065-T5
- Please consult Sunman engineering certificates for more information. Any other roof sheeting requires consultation with Sunman or its local importer.

b. Site planning

- Do not install using quick bonding method when rain is present
- Do not install using quick bonding method when wind speeds are greater than 10m/s are present at the site within 24 hours
- Roof temperature and ambient temperature during installation shall be between -15°C and 45°C during application of silicone, as per the installation manuals of the silicone.
- If the roof profile is Kliplok-406 or Kliplok-700, adhesion points are to be placed as specified in the appendix, otherwise a generic case installation is to be used.
- For generic install, the roof profile to meet the below requirements.
- Do not install the SMD panel directly over screw lines

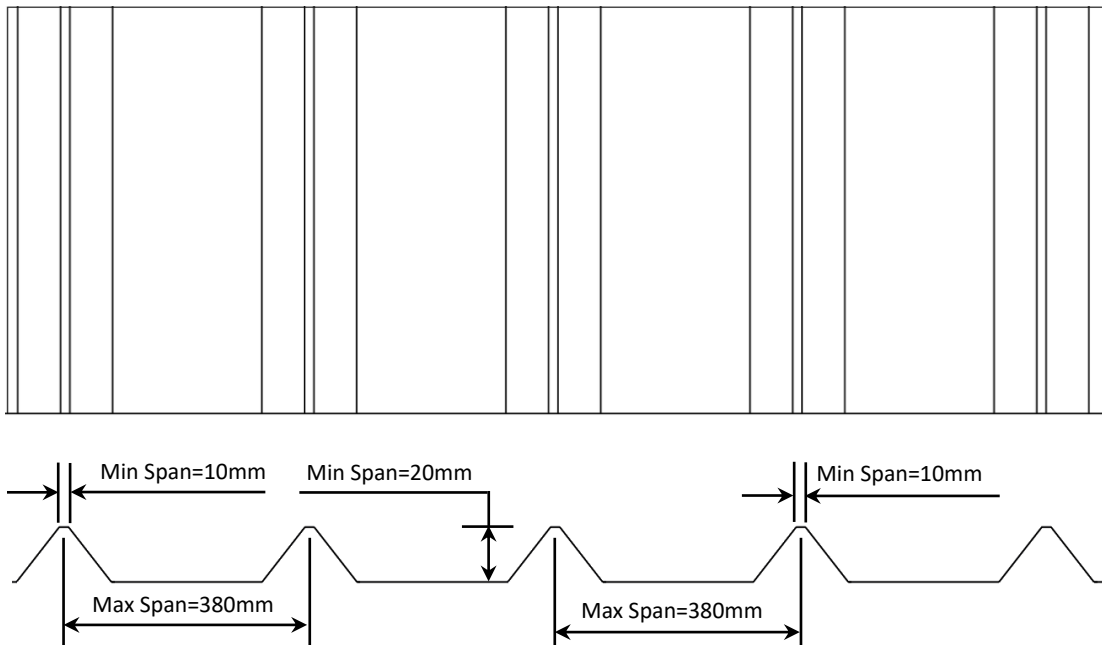

c. Preparation of bonding material

- Prepare silicone nozzle by cutting a circular opening 5-8mm wide, then cutting a V shape to one side 5-8mm long. This will ensure proper wet-out onto the substrate and a uniform adhesive thickness is achieved. Fix the nozzle onto the silicone gun.

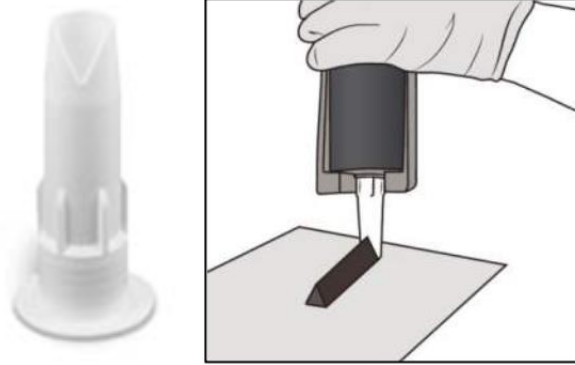

d. Clean the color steel roofing

- To ensure silicone achieves sufficient bond, the roof must be thoroughly cleaned, free of dirt, debris and metal powder. If you are unsure of the state of the roof, please contact Sunman for assistance.
- Clean off excess dirt and debris off the roof sheet with rags and water. Leave to dry. If it is extremely dirty, pressure cleaning with water is recommended.
- If using Tonsan 1527, clean the roof with isopropyl alcohol and wait to dry.
- If using Sika SG-20, apply the Sika Aktivator-205 on to clean cloth. Wiping down the roof, apply to the adhesion area. Reapply until clean. Leave to dry.

e. Install chemical bonding material

- Consult and strictly adhere to installation requirements specified in the Sunman engineering certificates
- Do not install apply silicone to roof while moisture is present
- Apply the silicon with the nozzle perpendicular to the roof. The length of the chemical bonding material shall span the full length of the contact interface, i.e. if the panel is installed in landscape, the silicone bead shall span the full width of panel and if the panel is installed in portrait, the silicone bead shall span the full length of panel
- Do not let a “skin” form over the silicone. This will directly impede the final curing strength. To manage this, only apply enough silicone to the roof for one module at a time. See note from Sika installation manual below on how to check for the presence of a “skin” over the silicone:

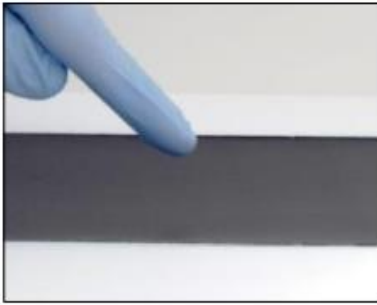

Picture 10: Start at the beginning of the bead

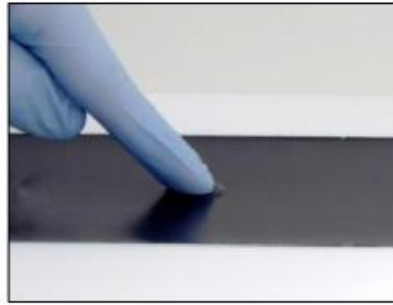

Picture 11: Touch slightly the bead with the finger

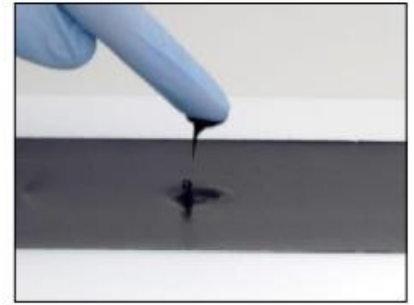

Picture 12: Remove and check for residues

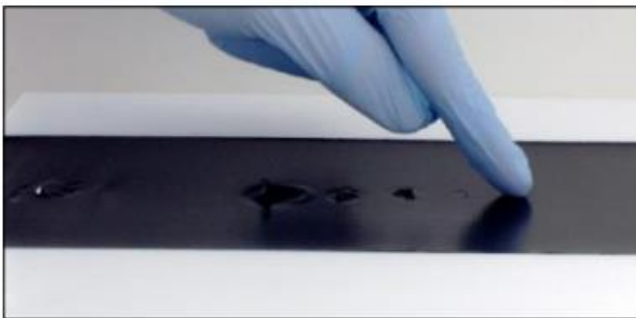

Picture 13: Always change the position for the next test

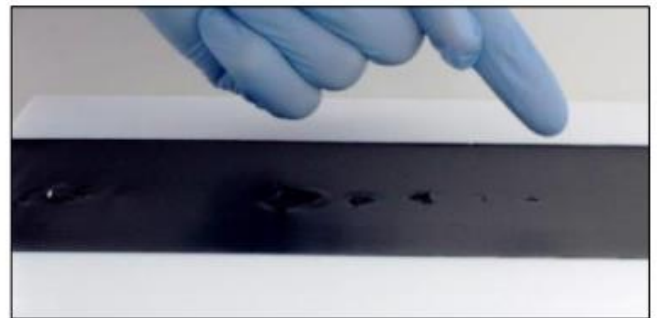

Picture 14: If no residues on your fingers are recognized the skin-over time has been reached

- Please see below for proper bead application

<p>✔ Correct dimension ($h \approx 5 \text{ mm}$)</p>	<p>❌ Too flat</p>
<p>❌ Too high, too small</p>	<p>❌ Poor wetting</p>

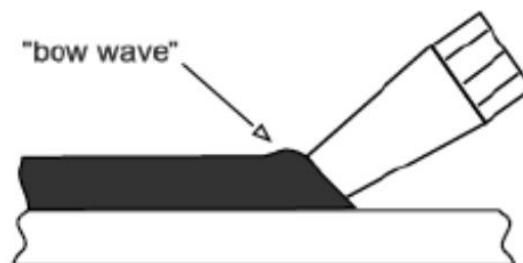

f. Layout of SMD Series

- Layout (For SMD Series: SMDxxxM-6X12DW, SMDxxxM-6X12UW, SMDxxxM-6X10DW, SMDxxxM-6X10UW)

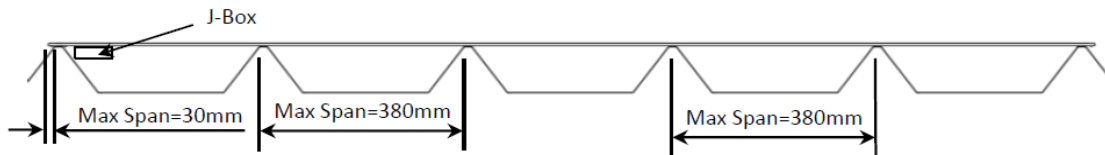
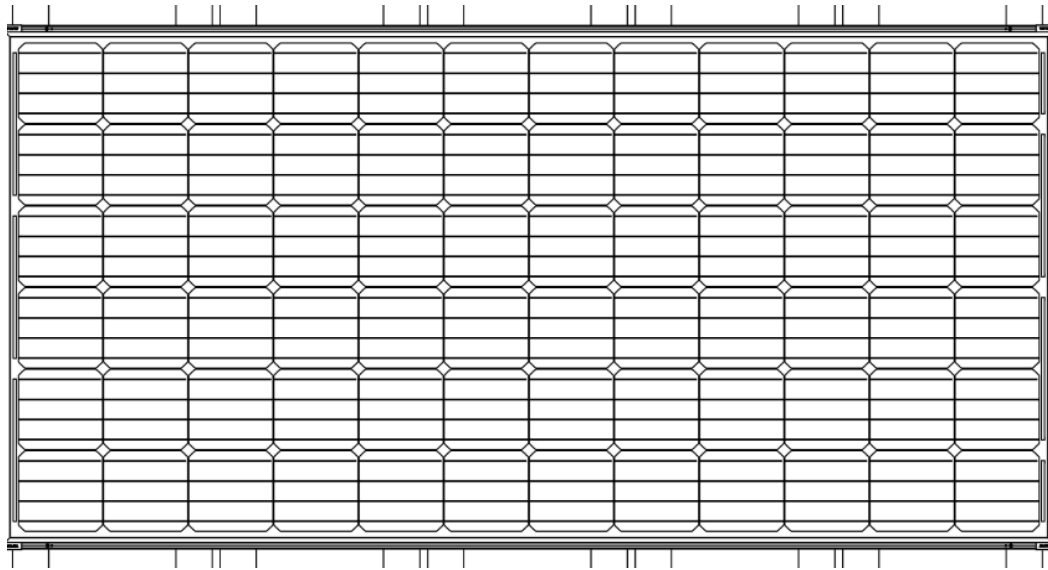

- Layout (For SMD Series: SMDxxxM-4X12DW, SMDxxxM-4X12UW, SMDxxxM-4X09DW, SMDxxxM-4X09UW)

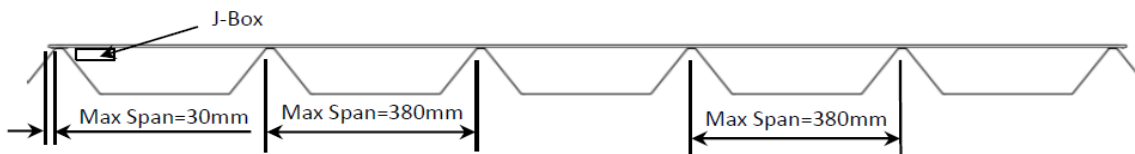
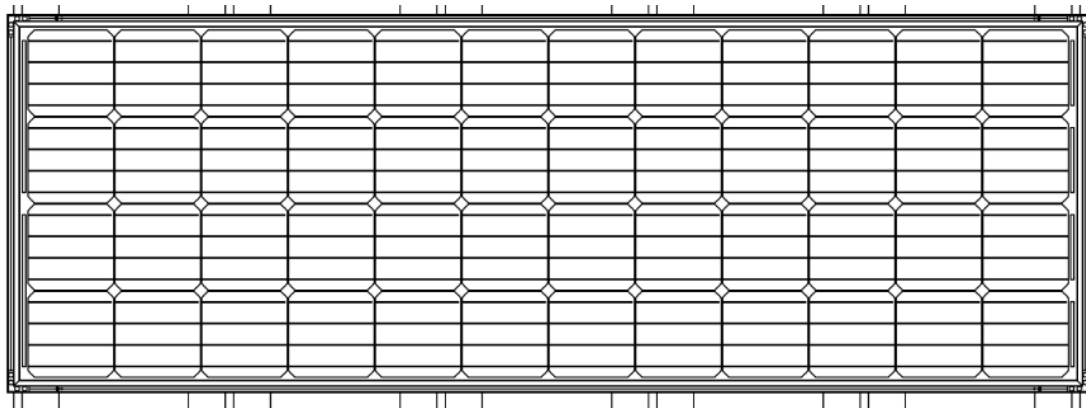

- Layout for landscape installation with generic roof profile

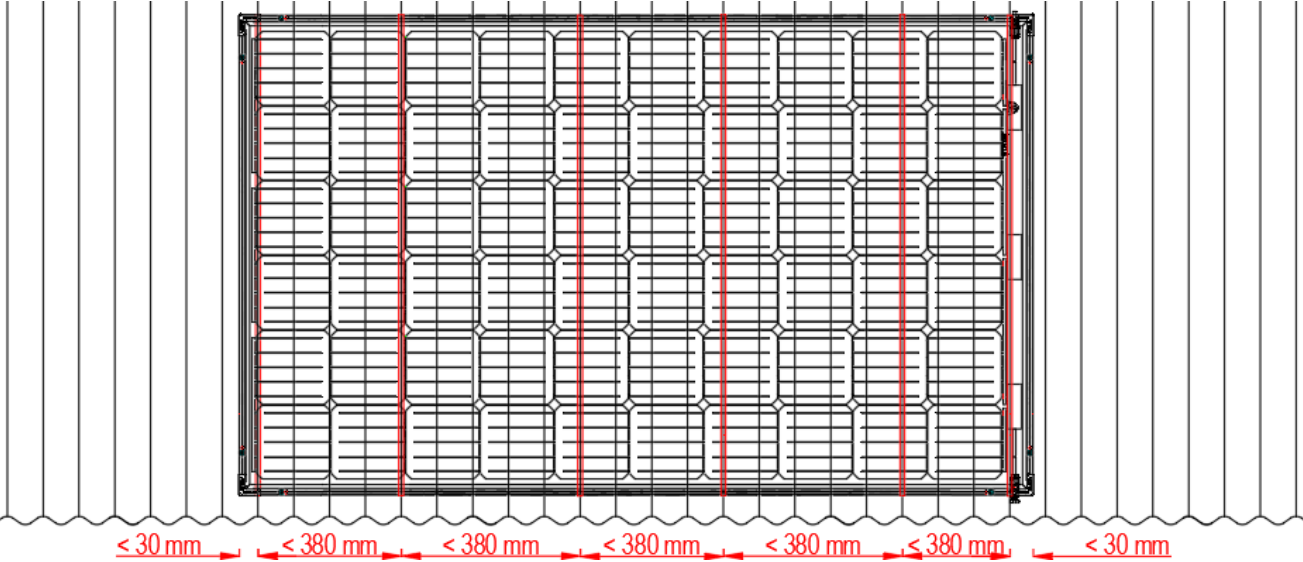
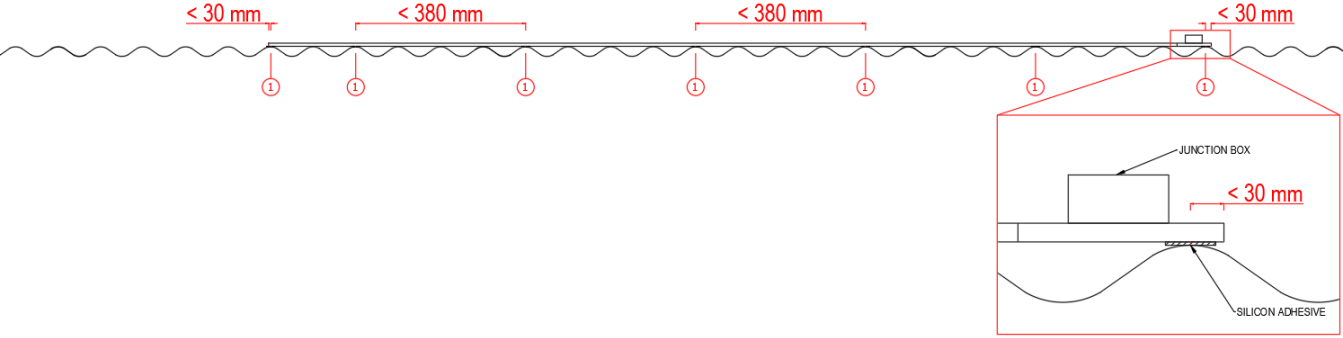
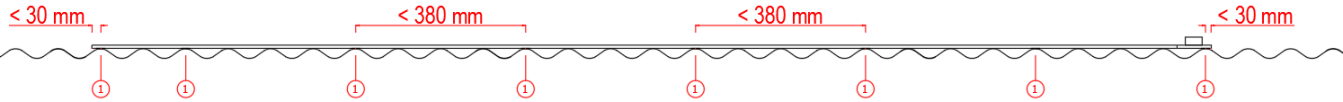

- Layout for portrait installation with generic roof profile

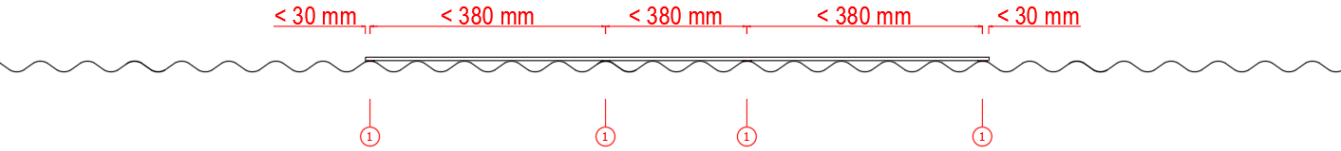

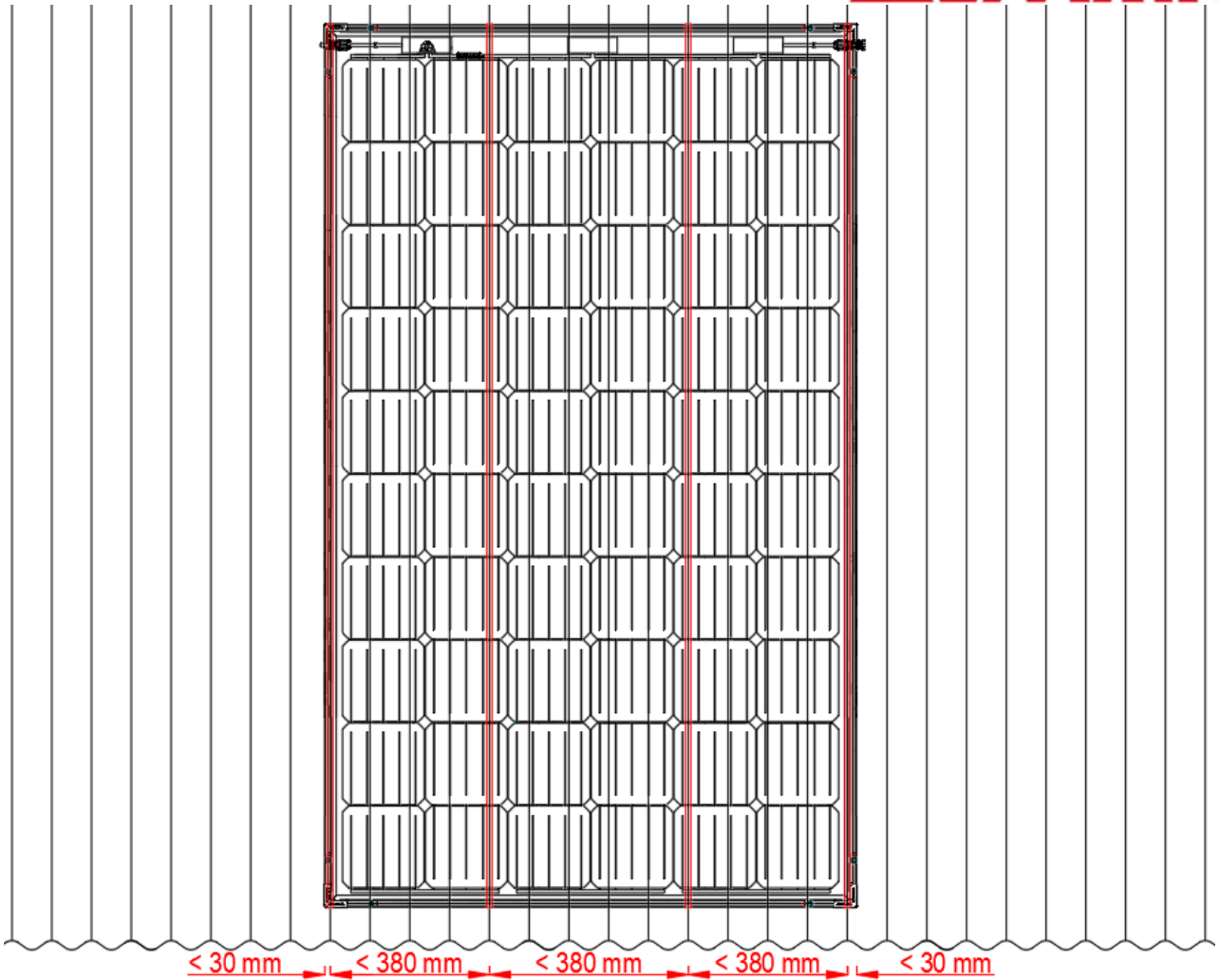

- Layout for rail mounting



►Note:

- Please refer to appendix regarding Kliplok 406-like and Kliplok 700-like roof sheeting mounting.
- Please contact the local distributors if you are not sure whether your color steel roofing is suit for SMD Series or you have any question about this installation method.
- Please contact the local distributors if you want to remove SMD Series from your color steel roofing.
- If installation method is strictly adhered to, Sunman will provide a 10 year warranty for the Tonsan 1527

Framed Installation

►For SMB Series

SMBxxxM-6X10DW, SMBxxxM-4X12DW, SMBxxxM-4X09DW, SMBxxxM-6X12UW,
 SMBxxxM-6X10UW, SMBxxxM-4X12UW, SMBxxxM-4X09UW, SMBxxxF-6X24DW,

SMBxxxF-6X20DW, SMBxxxF-4X24DW, SMBxxxF-4X18DW, SMBxxxF-6X24DB,
SMBxxxF-6X20DB, SMBxxxF-4X24DB, SMBxxxF-4X18DB

- Clamps can be used for the connection of SMB series components and support system. The installation must be completed according to the following example, otherwise the warranty will be invalid.
- Horizontal installation of SMB series components.
- SMB series components must be properly secured to their supports so that they can withstand the pressure of the load, including the rise and pressure of the wind. It is the responsibility of the installer to ensure that the mounting fixture used ensures that the assembly is strong enough.

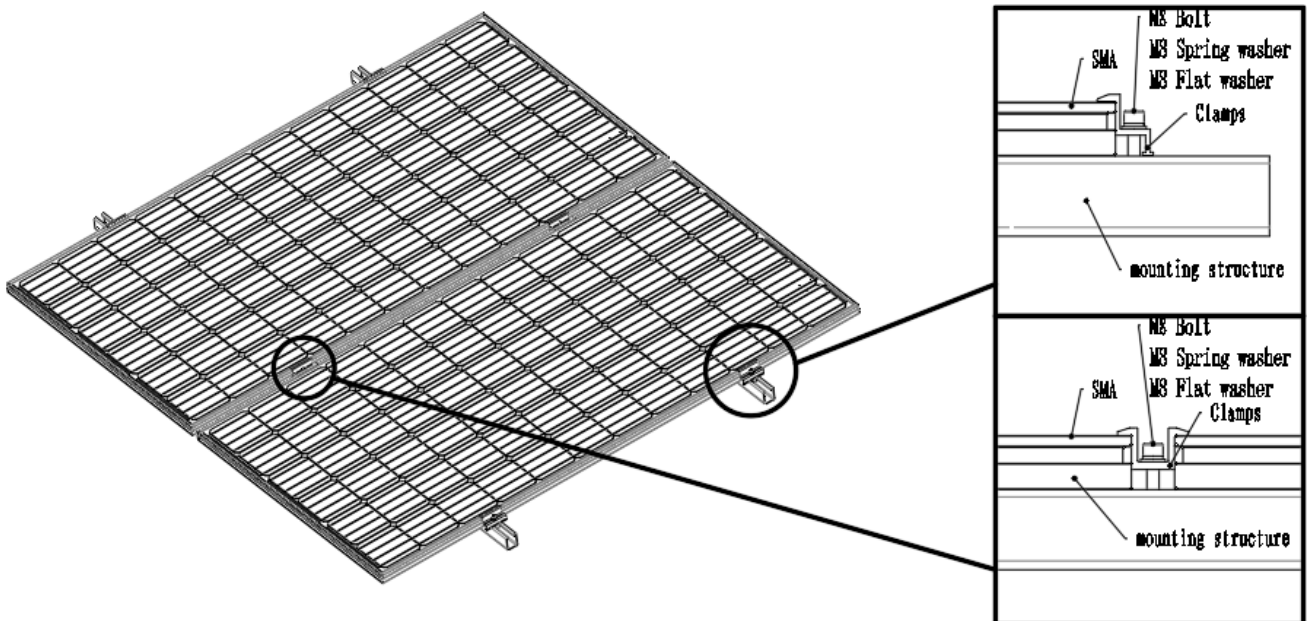

- Layout(For SMB Series: SMBxxxM-6X12DW, SMBxxxM-6X10DW, SMBxxxM-4X12DW, SMBxxxM-4X09DW, SMBxxxM-6X12UW, SMBxxxM-6X10UW, SMBxxxM-4X12UW, SMBxxxM-4X09UW, SMBxxxF-6X24DW; SMBxxxF-6X20DW; SMBxxxF-4X24DW; SMBxxxF-4X18DW; SMBxxxF-6X24DB; SMBxxxF-6X20DB; SMBxxxF-4X24DB; SMBxxxF-4X18DB)

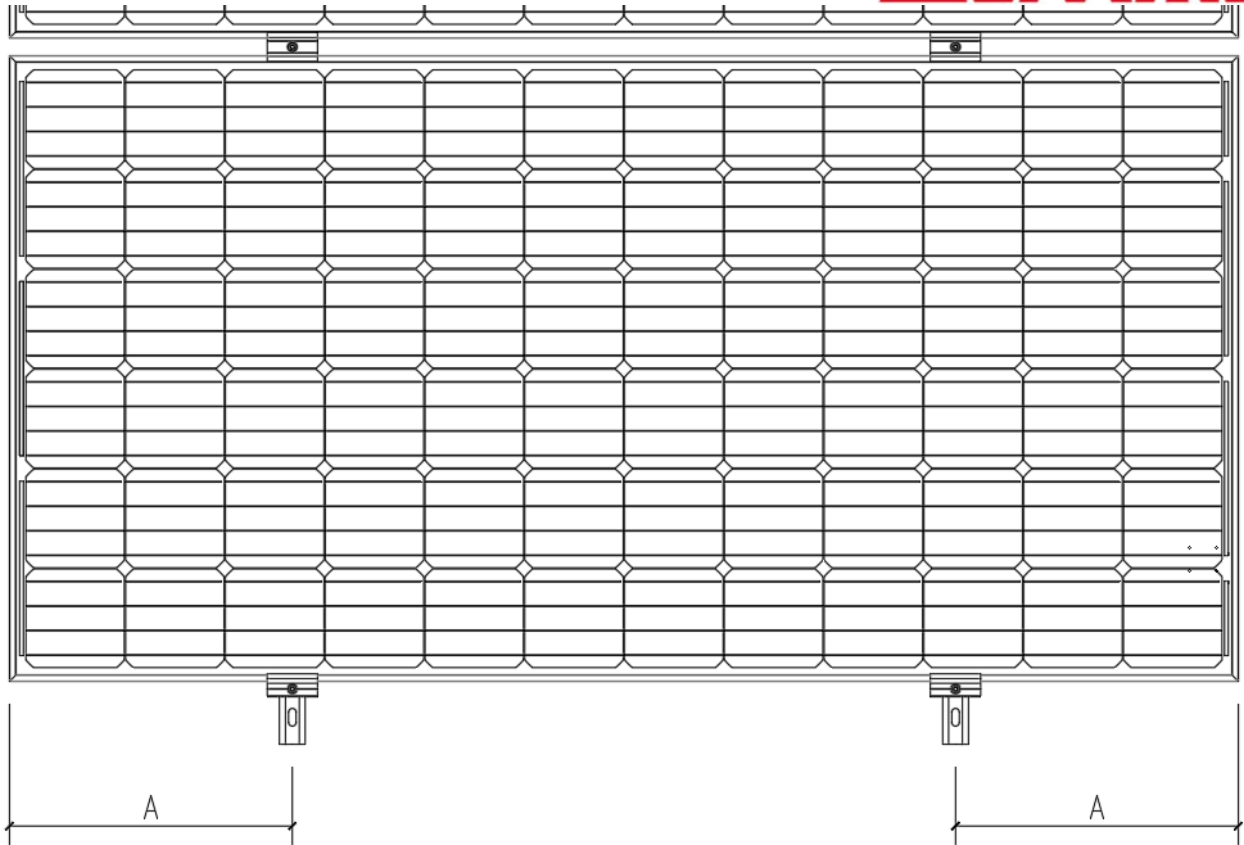

Specifications	$A_{MAX}(mm)$	$A_{MIN}(mm)$
SMBxxxM-6X12DW; SMBxxxM-6X12UW; SMBxxxF-6X24DW; SMBxxxF-6X24DB	450	250
SMBxxxM-6X10DW; SMBxxxM-6X10UW; SMBxxxF-6X20DW; SMBxxxF-6X20DB	400	210
SMBxxxM-4X12DW; SMBxxxM-4X12UW; SMBxxxF-4X24DW; SMBxxxF-4X24DB	450	250
SMBxxxM-4X09DW; SMBxxxM-4X09UW; SMBxxxF-4X18DW; SMBxxxF-4X18DB	350	200

Grounding

- For grounding and bonding requirements, please refer to regional and national safety and electricity standards. If grounding is required, use a recommended connector type for the grounding wire.
- For grounding, this guide refers to module frame grounding. If grounding is required, make sure module frames (metal exposed to touch) are always grounded.
- SUNMAN recommends always refer to local state and national code requirements for PV module grounding. SUNMAN highly recommends negative grounding if it's allowed by local authorities.
- When attaching the frame grounding hardware and wire to the frame it must be placed corresponding to the ground symbol stamped location to ensure proper electrical connection.
- For grounding should be performed by a qualified electrician.

For SMF Series

- Earthing and bonding requirements as per AS5033 Australian standards require fixing an earth conductor to the exposed conductive parts of the PV array. The SMF series panels do not have any exposed conductive parts as part of their construction. Due to this, the panels do not require earthing. This does not exempt the rest of the installation from the requirement of earthing.

For SMD Series

Grounding layouts

- In order to provide a conductivity path between the panel frames, an earth lug has been provided on the frame of the panel. The most efficient way to earth the panel and maintain continuity is to pull through the earth cable through the ducting and fix earth cable at each lug. This branch of earth cable can then be connect to the main return earth cable going back to a common ground.

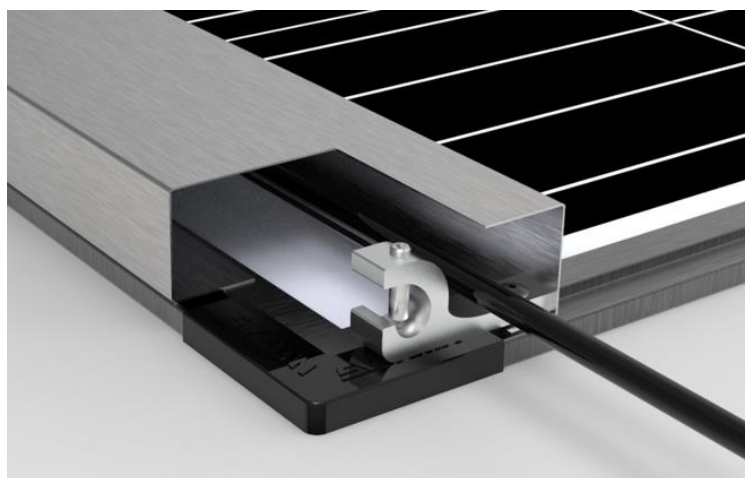

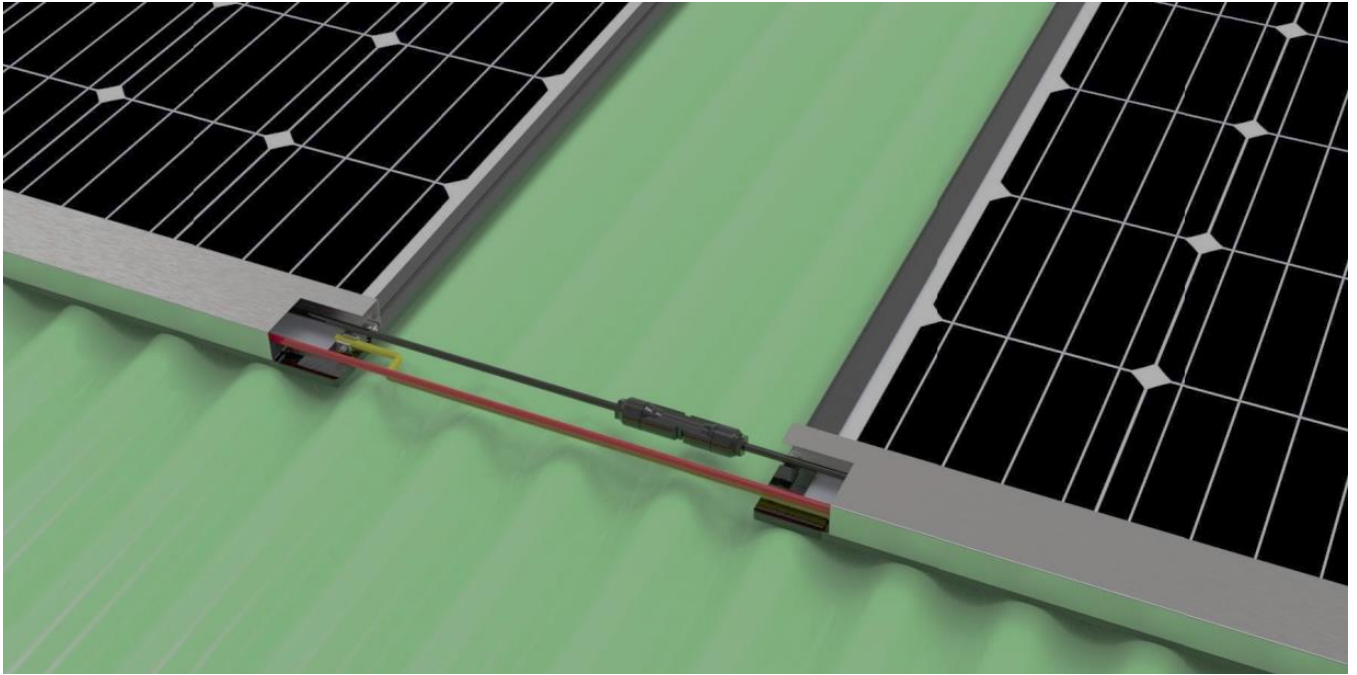

For SMB Series

- All modules frame and mounting must be earthed as per the installer's National Standard.
- Proper grounding is achieved by bonding all conductors on the module frame and metal mounting structures continuously with a suitable grounding conductor.
- Third party grounding solutions are acceptable. These solutions must comply with local standards and all associated manufacturer instructions.

Electrical installation

- Any hardware used must be compatible with the mounting structure material to avoid galvanic corrosion.
- It is not recommended to use eArc with different configurations in the same system.
- Excessive cables must be organized or fixed in an adequate way, e.g. attached to the mounting structure by using cable ties.
- For applications requiring high operating voltage several eArc can be connected in series to form a string of eArc; the system voltage is then equal to the sum of the voltage of each eArc.
- For applications requiring high operating currents several strings of eArc can be connected in parallel; the system current is then equal to the sum of the current of each string of eArc.
- The maximum system voltage is 1000 volts DC.
- The maximum number of series connected eArc depends on system design, the type of inverter used and environmental conditions.
- Please make sure no more than two strings in parallel if eArc without any fuse or blocking diode to be connected according to the maximum series fuse rating of eArc and local electrical installation code.
- There is no limitation on the number of eArc that can be connected in parallel (fuse for each string should be considered), the number of eArc is determined by system design parameters such as current or power output.
- To prevent the cables and the connectors from overheating, the cross section of the cables and the capacity of the connectors must be selected to suit the maximum system short circuit current. The recommended cable is PV wire (temperature rating is 90°C) with a cross section of at least 2.5mm².
- Please refer to local regulations to determine the system wires size, type and temperature.
- eArc are supplied with connectors to be used for system electrical connections. Please refer to the local regulations and the datasheets for which connectors are allowed to be used.
- To ensure reliable electric connection and to prevent possible intrusion of humidity, connectors must be mated and locked together until a click can be heard.
- Long-term exposure to wet environments may cause connectors' poor connectivity, resulting in current leakage and poor conductivity. SUNMAN recommend proper connector/cable/wire management to prevent moisture intrusion. Depending on the amount of humidity, SUNMAN recommends periodic inspections of the installation system to maintain optimal eArc' performance.
- The DC current generated by photovoltaic systems can be converted into AC and fed into a public Grid. As local utilities' policies on connecting renewable energy systems to the Grids vary from region to region. Always seek the advice from a qualified system designer or integrator. Building permits, inspections and approvals by the local utility are to be expected.

Maintenance and care

- A well designed solar system requires minimal maintenance; however, system performance and reliability can be improved by taking note of the following
- Maintenance should be carried out once a year by trained personnel.
- Inspect all cables to verify that connections are tight and the cables are adequately protected
- Trim any flora that would shade and negatively affect performance
- If using the adhesive installation, conduct a pull test on a panel to ensure the proper installation
- If using the standard mounting, verify that all the mounting screws and nuts are properly torqued
- Check all the string fuses
- Replacement modules must be of the same type and follow local regulations for replacement.
- The panels are designed such that occasional rain should clean the modules clean and minimise soiling losses. However if it is in a location that is particularly dusty and dirty, if there has been a lack of rain or if there has been weather conditions that would significantly soil the panels, manual cleaning is recommended. The necessity of cleaning can be done by measuring and recording the inverter's generation over time. For this reason it is recommended to monitor your inverter with either first party or third party products.
- While cleaning the module, use a soft cloth or mop with a mild detergent and water. Take care to avoid thermal shock which may damage the panel.
- **Product replacement:** In the event that a module is damaged and needs to be replaced
 - Follow safety precautions noted earlier in the installation manual and local electrical procedures
 - Disconnect the affected array string
 - Disconnect the connectors of the affected module including the earth
 - Remove the panel. This can be done by either cutting the adhesive with a wire saw or by following the mounting manufacturer's installation manual
 - Replace damaged module with new module of same characteristics
 - Check the open circuit voltage of the array and verify that it is within acceptable tolerances of the other strings it is to be connected in parallel with.
 - Restart solar system
- **Troubleshooting:** If your installation is not functioning normally, please contact the installer of the system
- **Reporting technical issues or warranty claims:**
 - Contact the installer
 - Contact the local distributor of the Sunman panel

Disclaimer of liability

- As the adherence to this manual and the conditions or methods of installation, operation, use and maintenance of photovoltaic (PV) products are beyond SUNMAN's control, SUNMAN does not accept responsibility and expressly disclaims liability for any loss, damage, or expense arising out of or in any way connected with such installation, operation, use or maintenance.
- No responsibility is assumed by SUNMAN for any infringement of patents or other rights of third parties, which may result from the use of the PV product. No license is granted by implication or otherwise under any patent or patent rights.
- The information in this manual is based on SUNMAN's best knowledge and experience and is believed to be reliable; But such information including product specification (without limitations) and suggestions do not constitute a warranty, express or implied. SUNMAN reserves the right to change the manual, eArc, the specifications, or product information sheets without prior notice.

Products Data

Series	STC					Dimensions	Weight	Fuse Rating	Max.series quantity
	Pmp	Vmp	Imp	Voc	Isc				
SMDxxxF-6X24UW (415-440) SMDxxxF-6X24DW (415-440) SMDxxxF-6X24UB (405-430) SMDxxxF-6X24DB (405-430)	440	42.4	10.38	50.2	10.88	2149mm X 1075mm X 5.6mm	8.3kg	20A	15
	435	42.2	10.31	50.0	10.81				
	430	42.0	10.24	49.8	10.74				
	425	41.8	10.17	49.6	10.67				
	420	41.6	10.10	49.4	10.60				
	415	41.4	10.03	49.2	10.53				
	410	41.2	9.96	49.0	10.46				
	405	41.0	9.88	48.8	10.38				
SMDxxxF-6X20UW (345-365) SMDxxxF-6X20DW (345-365) SMDxxxF-6X20UB (335-355) SMDxxxF-6X20DB (335-355)	365	35.1	10.40	41.5	10.90	1809mm X 1075mm X 5.6mm	7.1kg	20A	19
	360	34.9	10.32	41.3	10.82				
	355	34.7	10.24	41.1	10.72				
	350	34.5	10.15	40.9	10.62				
	345	34.3	10.06	40.7	10.52				
	340	34.1	9.98	40.5	10.42				
	335	33.9	9.89	40.3	10.32				
SMDxxxF-4X24UW (275-290) SMDxxxF-4X24DW (275-290) SMDxxxF-4X24UB (270-285) SMDxxxF-4X24DB (270-285)	290	27.9	10.40	33.1	10.90	2149mm X 729mm X 5.6mm	5.9kg	20A	24
	285	27.7	10.29	32.9	10.78				
	280	27.5	10.19	32.7	10.68				
	275	27.3	10.08	32.5	10.57				
	270	27.1	9.97	32.3	10.46				
SMDxxxF-4X18UW (205-220) SMDxxxF-4X18DW (205-220) SMDxxxF-4X18UB (200-215) SMDxxxF-4X18DB (200-215)	220	21.2	10.38	25.1	10.88	1639mm X 729mm X 5.6mm	4.7kg	20A	31
	215	21.0	10.24	24.9	10.72				
	210	20.8	10.10	24.7	10.58				
	205	20.6	9.96	24.5	10.44				
	200	20.4	9.81	24.3	10.29				
SMBxxxF-6X24DW (415-440) SMBxxxF-6X24DB (405-430)	440	42.4	10.38	50.2	10.88	2125mm X 1051mm X 35mm	11.2kg	20A	15
	435	42.2	10.31	50.0	10.81				
	430	42.0	10.24	49.8	10.74				
	425	41.8	10.17	49.6	10.67				
	420	41.6	10.10	49.4	10.60				
	415	41.4	10.03	49.2	10.53				
	410	41.2	9.96	49.0	10.46				
	405	41.0	9.88	48.8	10.38				
SMBxxxF-6X20DW (345-365) SMBxxxF-6X20DB (335-355)	365	35.1	10.40	41.5	10.90	1785mm X 1051mm X 35mm	9.6kg	20A	19
	360	34.9	10.32	41.3	10.82				
	355	34.7	10.24	41.1	10.72				
	350	34.5	10.15	40.9	10.62				
	345	34.3	10.06	40.7	10.52				
	340	34.1	9.98	40.5	10.42				
	335	33.9	9.89	40.3	10.32				
SMBxxxF-4X24DW (275-290) SMBxxxF-4X24DB (270-285)	290	27.9	10.40	33.1	10.90	2125mm X 705mm X 35mm	8.2kg	20A	24
	285	27.7	10.29	32.9	10.78				
	280	27.5	10.19	32.7	10.68				
	275	27.3	10.08	32.5	10.57				
	270	27.1	9.97	32.3	10.46				
SMBxxxF-4X18DW (205-220) SMBxxxF-4X18DB (200-215)	220	21.2	10.38	25.1	10.88	1615mm X 705mm X 35mm	6.6kg	20A	31
	215	21.0	10.24	24.9	10.72				
	210	20.8	10.10	24.7	10.58				

	205	20.6	9.96	24.5	10.44				
	200	20.4	9.81	24.3	10.29				
SMFxxxF-6X24UW (415-440) SMFxxxF-6X24DW (415-440) SMFxxxF-6X24UB (405-430) SMFxxxF-6X24DB (405-430)	440	42.4	10.38	50.2	10.88	2120mm X 1046mm X 2mm	7.2kg	20A	15
	435	42.2	10.31	50.0	10.81				
	430	42.0	10.24	49.8	10.74				
	425	41.8	10.17	49.6	10.67				
	420	41.6	10.10	49.4	10.60				
	415	41.4	10.03	49.2	10.53				
	410	41.2	9.96	49.0	10.46				
405	41.0	9.88	48.8	10.38					
SMFxxxF-6X20UW (345-365) SMFxxxF-6X20DW (345-365) SMFxxxF-6X20UB (335-355) SMFxxxF-6X20DB (335-355)	365	35.1	10.40	41.5	10.90	1780mm X 1046mm X 2mm	6.1kg	20A	19
	360	34.9	10.32	41.3	10.82				
	355	34.7	10.24	41.1	10.72				
	350	34.5	10.15	40.9	10.62				
	345	34.3	10.06	40.7	10.52				
	340	34.1	9.98	40.5	10.42				
335	33.9	9.89	40.3	10.32					
SMFxxxF-4X24UW (275-290) SMFxxxF-4X24DW (275-290) SMFxxxF-4X24UB (270-285) SMFxxxF-4X24DB (270-285)	290	27.9	10.40	33.1	10.90	2120mm X 700mm X 2mm	4.9kg	20A	24
	285	27.7	10.29	32.9	10.78				
	280	27.5	10.19	32.7	10.68				
	275	27.3	10.08	32.5	10.57				
	270	27.1	9.97	32.3	10.46				
SMFxxxF-4X18UW (205-220) SMFxxxF-4X18DW (205-220) SMFxxxF-4X18UB (200-215) SMFxxxF-4X18DB (200-215)	220	21.2	10.38	25.1	10.88	1610mm X 700mm X 2mm	3.8kg	20A	31
	215	21.0	10.24	24.9	10.72				
	210	20.8	10.10	24.7	10.58				
	205	20.6	9.96	24.5	10.44				
	200	20.4	9.81	24.3	10.29				
SMFxxxF-12X12UW (415-440) SMFxxxF-12X12UB (415-440) SMFxxxF-12X12DW (415-440) SMFxxxF-12X12DB (415-440)	440	42.4	10.38	50.2	10.88	2054mm X 1093mm X 2mm	7.3kg	20A	15
	435	42.2	10.31	50.0	10.81				
	430	42.0	10.24	49.8	10.74				
	425	41.8	10.17	49.6	10.67				
	420	41.6	10.10	49.4	10.60				
	415	41.4	10.03	49.2	10.53				
SMFxxxF-12X09UW (310-330) SMFxxxF-12X09UB (310-330)	330	31.6	10.45	37.4	10.95	2100mm X 860mm X 2mm	5.9kg	20A	21
	325	31.4	10.36	37.2	10.86				
	320	31.2	10.26	37.0	10.76				
	315	31.0	10.17	36.8	10.67				
	310	30.8	10.07	36.6	10.57				
SMFxxxF-12X08UW (275-290) SMFxxxF-12X08UB (275-290) SMFxxxF-12X08DW (275-290) SMFxxxF-12X08DB (275-290)	290	27.9	10.40	33.1	10.90	2054mm X 753mm X 2mm	5.0kg	20A	24
	285	27.7	10.29	32.9	10.78				
	280	27.5	10.19	32.7	10.68				
	275	27.3	10.08	32.5	10.57				
SMFxxxF-12X04UW (135-145) SMFxxxF-12X04UB (135-145) SMFxxxF-12X04DW (135-145) SMFxxxF-12X04DB (135-145)	145	13.8	10.51	16.4	10.97	2054mm X 413mm X 2mm	2.8kg	20A	48
	140	13.6	10.30	16.2	10.76				
	135	13.4	10.08	16.0	10.54				

Series	STC					Dimensions	Weight	Fuse Rating	Max.series quantity
	Pmp	Vmp	Imp	Voc	Isc				
SMDxxxM-6X12DW (158.75)	380	40.5	9.39	48.8	9.92	2003mm X 1029mm X 5.6mm	6.8kg	20A	16
	375	40.2	9.33	48.6	9.86				
	370	39.9	9.28	48.4	9.81				
	365	39.6	9.22	48.2	9.75				

SMDxxxM-6X10DW (158.75)	315	33.6	9.38	40.7	9.90	1682mm X 1029mm X 5.6mm	5.8kg	20A	19
	310	33.3	9.31	40.5	9.81				
	305	33.0	9.25	40.3	9.74				
SMDxxxM-4X12DW (158.75)	250	26.8	9.33	32.1	9.85	2003mm X 700mm X 5.6mm	4.9kg	20A	24
	245	26.5	9.25	31.9	9.77				
	240	26.2	9.17	31.7	9.69				
SMDxxxM-4X09DW (158.75)	190	20.2	9.41	24.3	9.88	1521mm X 700mm X 5.6mm	3.8kg	20A	32
	185	19.9	9.30	24.1	9.78				
	180	19.6	9.19	23.9	9.69				
SMDxxxM-6X12UW (158.75)	380	40.5	9.39	48.8	9.92	2031mm X 1029mm X 5.6mm	6.9kg	20A	16
	375	40.2	9.33	48.6	9.86				
	370	39.9	9.28	48.4	9.81				
	365	39.6	9.22	48.2	9.75				
SMDxxxM-6X10UW (158.75)	315	33.6	9.38	40.7	9.90	1710mm X 1029mm X 5.6mm	6.0kg	20A	19
	310	33.3	9.31	40.5	9.81				
	305	33.0	9.25	40.3	9.74				
SMDxxxM-4X12UW (158.75)	250	26.8	9.33	32.1	9.85	2031mm X 700mm X 5.6mm	5.0kg	20A	24
	245	26.5	9.25	31.9	9.77				
	240	26.2	9.17	31.7	9.69				
SMDxxxM-4X09UW (158.75)	190	20.2	9.41	24.3	9.88	1549mm X 700mm X 5.6mm	3.9kg	20A	32
	185	19.9	9.30	24.1	9.78				
	180	19.6	9.19	23.9	9.69				
SMBxxxM-6X12DW (158.75)	380	40.5	9.39	48.8	9.92	1979mm X 1005mm X 35mm	9.4kg	20A	16
	375	40.2	9.33	48.6	9.86				
	370	39.9	9.28	48.4	9.81				
	365	39.6	9.22	48.2	9.75				
SMBxxxM-6X10DW (158.75)	315	33.6	9.38	40.7	9.90	1658mm X 1005mm X 35mm	8.1kg	20A	19
	310	33.3	9.31	40.5	9.81				
	305	33.0	9.25	40.3	9.74				
SMBxxxM-4X12DW (158.75)	250	26.8	9.33	32.1	9.85	1979mm X 676mm X 35mm	7.0kg	20A	24
	245	26.5	9.25	31.9	9.77				
	240	26.2	9.17	31.7	9.69				
SMBxxxM-4X09DW (158.75)	190	20.2	9.41	24.3	9.88	1497mm X 676mm X 35mm	5.7kg	20A	32
	185	19.9	9.30	24.1	9.78				
	180	19.6	9.19	23.9	9.69				
SMBxxxM-6X12UW (158.75)	380	40.5	9.39	48.8	9.92	2007mm X 1005mm X 35mm	9.5kg	20A	16
	375	40.2	9.33	48.6	9.86				
	370	39.9	9.28	48.4	9.81				
	365	39.6	9.22	48.2	9.75				
SMBxxxM-6X10UW (158.75)	315	33.6	9.38	40.7	9.90	1686mm X 1005mm X 35mm	8.4kg	20A	19
	310	33.3	9.31	40.5	9.81				
	305	33.0	9.25	40.3	9.74				
SMBxxxM-4X12UW (158.75)	250	26.8	9.33	32.1	9.85	2007mm X 676mm X 35mm	7.2kg	20A	24
	245	26.5	9.25	31.9	9.77				
	240	26.2	9.17	31.7	9.69				
SMBxxxM-4X09UW (158.75)	190	20.2	9.41	24.3	9.88	1525mm X 676mm X 35mm	5.8kg	20A	32
	185	19.9	9.30	24.1	9.78				
	180	19.6	9.19	23.9	9.69				
SMFxxxM-6X12DW (158.75)	380	40.5	9.39	48.8	9.92	1974mm X 1000mm X 2mm	5.7kg	20A	16
	375	40.2	9.33	48.6	9.86				
	370	39.9	9.28	48.4	9.81				
	365	39.6	9.22	48.2	9.75				

SMFxxxM-6X10DW (158.75)	315	33.6	9.38	40.7	9.90	1653mm X 1000mm X 2mm	4.8kg	20A	19
	310	33.3	9.31	40.5	9.81				
	305	33.0	9.25	40.3	9.74				
SMFxxxM-4X12DW (158.75)	250	26.8	9.33	32.1	9.85	1974mm X 671mm X 2mm	3.9kg	20A	24
	245	26.5	9.25	31.9	9.77				
	240	26.2	9.17	31.7	9.69				
SMFxxxM-4X09DW (158.75)	190	20.2	9.41	24.3	9.88	1492mm X 671mm X 2mm	3.0kg	20A	32
	185	19.9	9.30	24.1	9.78				
	180	19.6	9.19	23.9	9.69				
SMFxxxM-6X12UW (158.75)	380	40.5	9.39	48.8	9.92	2002mm X 1000mm X 2mm	5.8kg	20A	16
	375	40.2	9.33	48.6	9.86				
	370	39.9	9.28	48.4	9.81				
	365	39.6	9.22	48.2	9.75				
SMFxxxM-6X10UW (158.75)	315	33.6	9.38	40.7	9.90	1681mm X 1000mm X 2mm	5.0kg	20A	19
	310	33.3	9.31	40.5	9.81				
	305	33.0	9.25	40.3	9.74				
SMFxxxM-4X12UW (158.75)	250	26.8	9.33	32.1	9.85	2002mm X 671mm X 2mm	4.0kg	20A	24
	245	26.5	9.25	31.9	9.77				
	240	26.2	9.17	31.7	9.69				
SMFxxxM-4X09UW (158.75)	190	20.2	9.41	24.3	9.88	1520mm X 671mm X 2mm	3.1kg	20A	32
	185	19.9	9.30	24.1	9.78				
	180	19.6	9.19	23.9	9.69				
SMFxxxM-5X12UW (158.75)	315	33.6	9.38	40.7	9.90	2020mm X 882mm X 2mm	5.0kg	20A	19
	310	33.3	9.31	40.5	9.81				
	305	33.0	9.25	40.3	9.74				
SMDxxxM-6X12DW (156.75)	355	39.5	8.99	48.1	9.51	1979mm X 1019mm X 5.6mm	6.5kg	20A	16
	350	39.2	8.93	47.9	9.46				
	345	38.9	8.87	47.7	9.41				
	340	38.6	8.81	47.5	9.36				
	335	38.3	8.75	47.3	9.31				
	330	38.0	8.69	47.1	9.22				
	325	37.7	8.63	46.9	9.13				
SMDxxxM-6X10DW (156.75)	295	32.8	9.00	40.1	9.52	1662mm X 1019mm X 5.6mm	5.5kg	20A	20
	290	32.6	8.90	39.9	9.43				
	285	32.4	8.80	39.7	9.34				
	280	32.2	8.70	39.5	9.25				
	275	32.0	8.60	39.3	9.16				
	270	31.8	8.50	39.1	9.07				
SMDxxxM-4X12DW (156.75)	235	26.1	9.01	31.7	9.54	1979mm X 689mm X 5.6mm	4.6kg	20A	25
	230	25.8	8.92	31.5	9.45				
	225	25.5	8.83	31.3	9.36				
	220	25.2	8.74	31.1	9.27				
	215	24.9	8.64	30.9	9.18				
SMDxxxM-4X09DW (156.75)	175	19.5	8.98	23.9	9.50	1503mm X 689mm X 5.6mm	3.7kg	20A	33
	170	19.2	8.86	23.7	9.39				
	165	18.9	8.74	23.5	9.28				
	160	18.6	8.61	23.2	9.17				
SMDxxxM-6X12UW (156.75)	355	39.5	8.99	48.1	9.51	2007mm X 1019mm X 5.6mm	6.6kg	20A	16
	350	39.2	8.93	47.9	9.46				
	345	38.9	8.87	47.7	9.41				
	340	38.6	8.81	47.5	9.36				

	335	38.3	8.75	47.3	9.31				
	330	38.0	8.69	47.1	9.22				
	325	37.7	8.63	46.9	9.13				
SMDxxxM-6X10UW (156.75)	295	32.8	9.00	40.1	9.52	1690mm X 1019mm X 5.6mm	5.6kg	20A	20
	290	32.6	8.90	39.9	9.43				
	285	32.4	8.80	39.7	9.34				
	280	32.2	8.70	39.5	9.25				
	275	32.0	8.60	39.3	9.16				
	270	31.8	8.50	39.1	9.07				
SMDxxxM-4X12UW (156.75)	235	26.1	9.01	31.7	9.54	2007mm X 689mm X 5.6mm	4.7kg	20A	25
	230	25.8	8.92	31.5	9.45				
	225	25.5	8.83	31.3	9.36				
	220	25.2	8.74	31.1	9.27				
	215	24.9	8.64	30.9	9.18				
SMDxxxM-4X09UW (156.75)	175	19.5	8.98	23.9	9.50	1531mm X 689mm X 5.6mm	3.8kg	20A	33
	170	19.2	8.86	23.7	9.39				
	165	18.9	8.74	23.5	9.28				
	160	18.6	8.61	23.2	9.17				
SMBxxxM-6X12DW (156.75)	355	39.5	8.99	48.1	9.51	1955mm X 995mm X 35mm	8.9kg	20A	16
	350	39.2	8.93	47.9	9.46				
	345	38.9	8.87	47.7	9.41				
	340	38.6	8.81	47.5	9.36				
	335	38.3	8.75	47.3	9.31				
	330	38.0	8.69	47.1	9.22				
	325	37.7	8.63	46.9	9.13				
SMBxxxM-6X10DW (156.75)	295	32.8	9.00	40.1	9.52	1638mm X 995mm X 35mm	7.6kg	20A	20
	290	32.6	8.90	39.9	9.43				
	285	32.4	8.80	39.7	9.34				
	280	32.2	8.70	39.5	9.25				
	275	32.0	8.60	39.3	9.16				
	270	31.8	8.50	39.1	9.07				
SMBxxxM-4X12DW (156.75)	235	26.1	9.01	31.7	9.54	1955mm X 665mm X 35mm	6.3kg	20A	25
	230	25.8	8.92	31.5	9.45				
	225	25.5	8.83	31.3	9.36				
	220	25.2	8.74	31.1	9.27				
	215	24.9	8.64	30.9	9.18				
SMBxxxM-4X09DW (156.75)	175	19.5	8.98	23.9	9.50	1479mm X 665mm X 35mm	5.0kg	20A	33
	170	19.2	8.86	23.7	9.39				
	165	18.9	8.74	23.5	9.28				
	160	18.6	8.61	23.2	9.17				
SMBxxxM-6X12UW (156.75)	355	39.5	8.99	48.1	9.51	1983mm X 995mm X 35mm	9.0kg	20A	16
	350	39.2	8.93	47.9	9.46				
	345	38.9	8.87	47.7	9.41				
	340	38.6	8.81	47.5	9.36				
	335	38.3	8.75	47.3	9.31				
	330	38.0	8.69	47.1	9.22				
	325	37.7	8.63	46.9	9.13				
SMBxxxM-6X10UW (156.75)	295	32.8	9.00	40.1	9.52	1666mm X 995mm X 35mm	7.7kg	20A	20
	290	32.6	8.90	39.9	9.43				
	285	32.4	8.80	39.7	9.34				
	280	32.2	8.70	39.5	9.25				

	275	32.0	8.60	39.3	9.16				
	270	31.8	8.50	39.1	9.07				
SMBxxxM-4X12UW (156.75)	235	26.1	9.01	31.7	9.54	1983mm X 665mm X 35mm	6.4kg	20A	25
	230	25.8	8.92	31.5	9.45				
	225	25.5	8.83	31.3	9.36				
	220	25.2	8.74	31.1	9.27				
	215	24.9	8.64	30.9	9.18				
SMBxxxM-4X09UW (156.75)	175	19.5	8.98	23.9	9.50	1507mm X 665mm X 35mm	5.1kg	20A	33
	170	19.2	8.86	23.7	9.39				
	165	18.9	8.74	23.5	9.28				
	160	18.6	8.61	23.2	9.17				
SMFxxxM-6X12DW (156.75)	355	39.5	8.99	48.1	9.51	1950mm X 990mm X 2mm	5.3kg	20A	16
	350	39.2	8.93	47.9	9.46				
	345	38.9	8.87	47.7	9.41				
	340	38.6	8.81	47.5	9.36				
	335	38.3	8.75	47.3	9.31				
	330	38.0	8.69	47.1	9.22				
	325	37.7	8.63	46.9	9.13				
SMFxxxM-6X10DW (156.75)	295	32.8	9.00	40.1	9.52	1633mm X 990mm X 2mm	4.4kg	20A	20
	290	32.6	8.90	39.9	9.43				
	285	32.4	8.80	39.7	9.34				
	280	32.2	8.70	39.5	9.25				
	275	32.0	8.60	39.3	9.16				
	270	31.8	8.50	39.1	9.07				
SMFxxxM-4X12DW (156.75)	235	26.1	9.01	31.7	9.54	1950mm X 660mm X 2mm	3.7kg	20A	25
	230	25.8	8.92	31.5	9.45				
	225	25.5	8.83	31.3	9.36				
	220	25.2	8.74	31.1	9.27				
	215	24.9	8.64	30.9	9.18				
SMFxxxM-4X09DW (156.75)	175	19.5	8.98	23.9	9.50	1474mm X 660mm X 2mm	2.8kg	20A	33
	170	19.2	8.86	23.7	9.39				
	165	18.9	8.74	23.5	9.28				
	160	18.6	8.61	23.2	9.17				
SMFxxxM-6X12UW (156.75)	355	39.5	8.99	48.1	9.51	1978mm X 990mm X 2mm	5.4kg	20A	16
	350	39.2	8.93	47.9	9.46				
	345	38.9	8.87	47.7	9.41				
	340	38.6	8.81	47.5	9.36				
	335	38.3	8.75	47.3	9.31				
	330	38.0	8.69	47.1	9.22				
	325	37.7	8.63	46.9	9.13				
SMFxxxM-6X10UW (156.75)	295	32.8	9.00	40.1	9.52	1661mm X 990mm X 2mm	4.6kg	20A	20
	290	32.6	8.90	39.9	9.43				
	285	32.4	8.80	39.7	9.34				
	280	32.2	8.70	39.5	9.25				
	275	32.0	8.60	39.3	9.16				
	270	31.8	8.50	39.1	9.07				
SMFxxxM-4X12UW (156.75)	235	26.1	9.01	31.7	9.54	1978mm X 660mm X 2mm	3.8kg	20A	25
	230	25.8	8.92	31.5	9.45				
	225	25.5	8.83	31.3	9.36				
	220	25.2	8.74	31.1	9.27				
	215	24.9	8.64	30.9	9.18				
SMFxxxM-4X09UW	175	19.5	8.98	23.9	9.50	1502mm X 660mm X 2mm	2.9kg	20A	33

(156.75)	170	19.2	8.86	23.7	9.39			
	165	18.9	8.74	23.5	9.28			
	160	18.6	8.61	23.2	9.17			

专业 DISCIPLINE	签字 SIGNATURE
总图 CI	
结构 ST	
给排水 PL	
暖通地区 HE	
工业管道 IP	
电气 EI	
自控 IC	
通信 IT	
工艺 PR	

注册结构工程师 REGISTERED ENGINEER

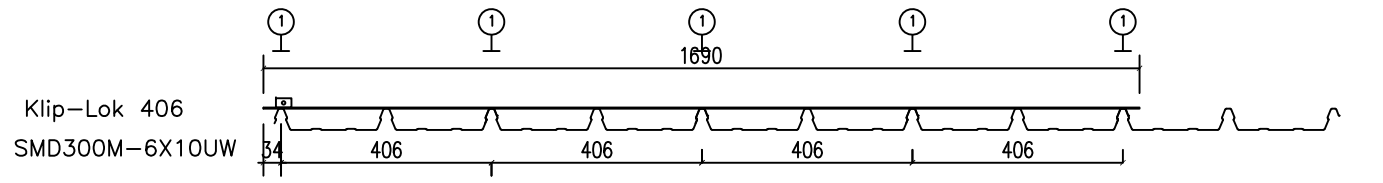
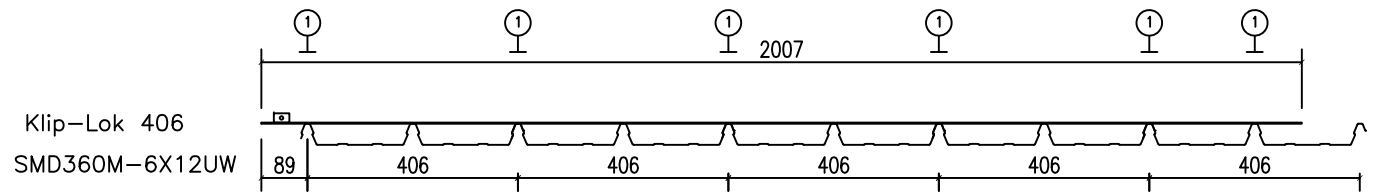
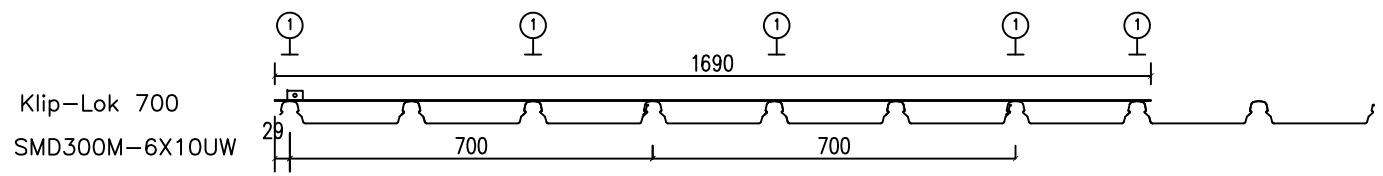
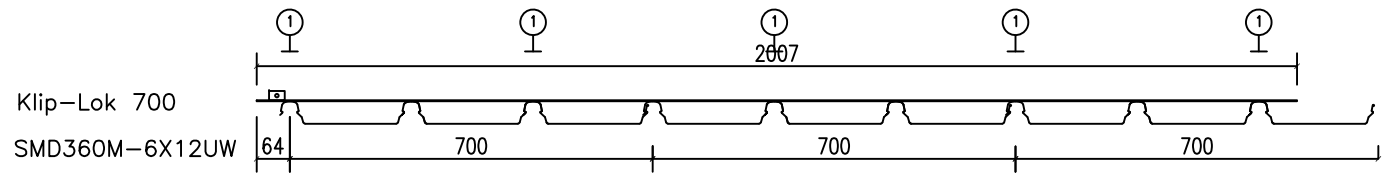

① Silicone paste surface

设计单位 DESIGNER

SUNMAN

编 号
性 质
电 话

审 定 Reviewed For Issue By	
审 核 Reviewed By	
专业负责人 Chief Professional	
校 对 Checked By	
设 计 Designed By	
设计单位 DESIGNER	

项目名称 PROJECT NAME

工程名称 ENGINEERING NAME

图名名称 DRAWING TITLE

工程编号 Project No.	设计阶段 Stage
比例 Scale	专业 Specialty
日期 Date	图号 Drawing No.

专业 DISCIPLINE	签字 SIGNATURE
总图 CI	
结构 ST	
给排水 PL	
暖通区 HE	
工业管 IP	
电气 EI	
自控 IC	
通信 IT	
工艺 TE	

注册结构工程师 REGISTERED ENGINEER

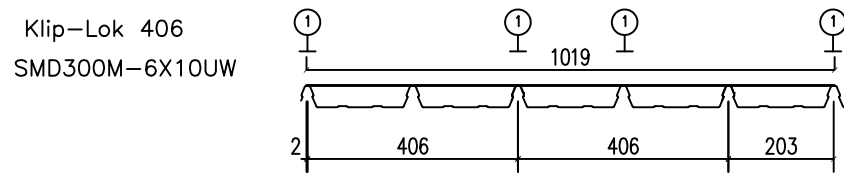
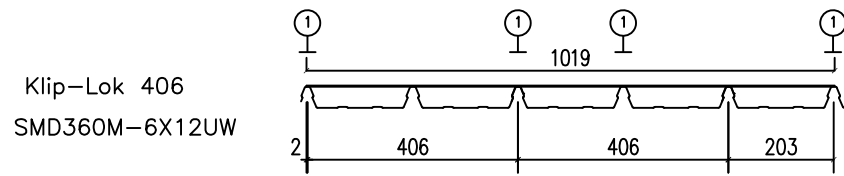
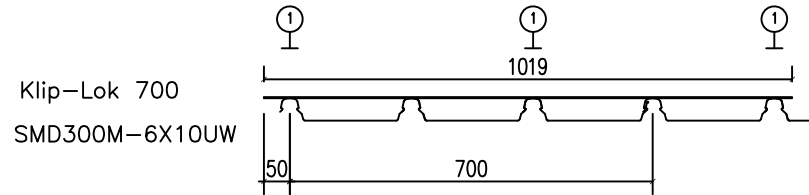
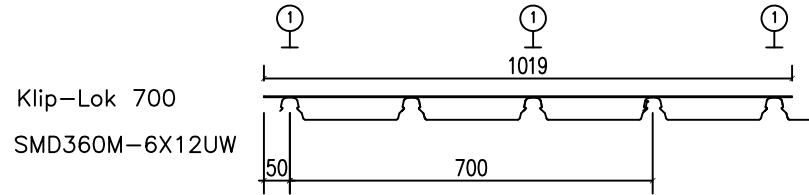

① Silicone paste surface

设计单位 DESIGNER

SUNMAN

编辑
姓名
电话

审定 Reviewed For Issue By	
审核 Reviewed By	
专业负责人 Chief Professional	
校对 Checked By	
设计 Designed By	
设计单位 ORDER	

项目名称 PROJECT NAME

工程名称 ENGINEERING NAME

图名名称 DRAWING TITLE

工程编号 Project No.	设计阶段 Stage
比例 Scale	专业 Specialty
日期 Date	图号 Drawing No.